

TECHNICAL PAPER

Equivalent Circuit Model for Tantalum and Niobium Oxide Capacitors for use in Simulation Software

J. Pelcak

*AVX Czech Republic s.r.o., Dvorakova 328,
563 01 Lanskroun, Czech Republic*

Abstract:

In electrical circuit simulations with simulation software, ideal passive components (resistors, capacitors, inductors) are typically used because real component characteristics have been difficult to model. Unfortunately, ideal and real passive components have significant differences in their electrical behavior. These differences lead to discrepancies between actual hardware performance and expected results based upon simulation software programs.

This paper will describe the development of equivalent circuit diagram for modeling real capacitor behavior. Use of this real model in simulation software can help make circuit development more efficient, as the circuits in the simulations should have similar behavior to the actual circuits.

The model presented here includes real component behavior for Tantalum and Niobium Oxide capacitors, with all factors such as ESR and inductance, and even includes the dependence on temperature.

EQUIVALENT CIRCUIT MODEL FOR TANTALUM AND NIOBIUM OXIDE CAPACITORS FOR USE IN SIMULATION SOFTWARE

J. Pelcak

AVX Czech Republic s.r.o., Dvorakova 328, 563 01 Lanskroun, Czech Republic

Phone: +420 465 358 127 Fax: +420 465 358 128, email pelcakj@avx.cz

ABSTRACT

In electrical circuit simulations with simulation software, ideal passive components (resistors, capacitors, inductors) are typically used because real component characteristics have been difficult to model. Unfortunately, ideal and real passive components have significant differences in their electrical behavior. These differences lead to discrepancies between actual hardware performance and expected results based upon simulation software programs.

This paper will describe the development of equivalent circuit diagram for modeling real capacitor behavior. Use of this real model in simulation software can help make circuit development more efficient, as the circuits in the simulations should have similar behavior to the actual circuits.

The model presented here includes real component behavior for Tantalum and Niobium Oxide capacitors, with all factors such as ESR and inductance, and even includes the dependence on temperature.

INTRODUCTION

All real components including capacitors have parasitic factors not taken into account in ideal models. These factors can have a major impact on electrical behavior within a circuit. Better understanding of real capacitor behavior can help to create more accurate solutions for circuit development. The use of an equivalent circuit that accurately represents the true behavior of a capacitor will yield a better understanding of response in the electrical circuit.

COMPARISON OF IDEAL AND REAL CAPACITORS

An Ideal capacitor has only a capacitance value, which does not depend on frequency, temperature, applied voltage, and has no parasitic equivalent series resistance (ESR), equivalent series inductance (ESL), and leakage current (LI).

Real capacitors have a capacitance value that varies with frequency, temperature and applied voltage, and also has significant ESR, ESL and LI parasitic electrical parameters. The magnitude of these

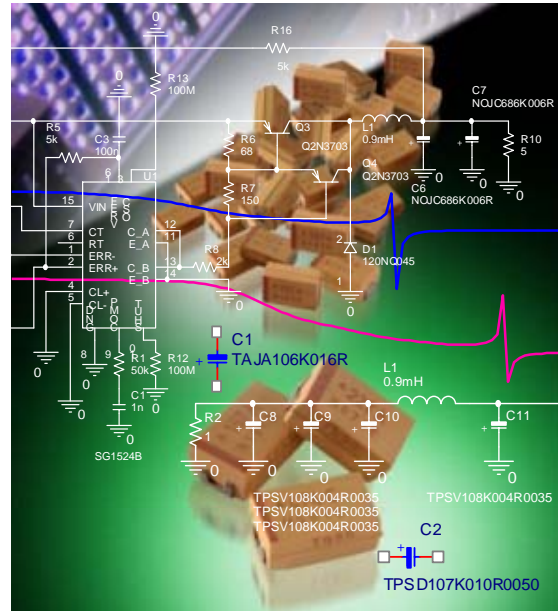

parasitic parameters depends on manufacturing technology, methods and material systems. The non-ideal parameters have significant influence on filtering, smoothing and other functions in electronic applications.

CHARACTERISTICS OF A REAL CAPACITOR

For a real capacitor, the capacitance value generally decreases with increasing frequency due to ESR, and there is a peak at the resonance frequency because of parasitic ESL.

The dielectric of a real capacitor is not an ideal insulator, so there is a leakage current through the component. Furthermore, Tantalum and Niobium Oxide capacitors are polar components, and due to the MIS structure [1] of the capacitor, the leakage behavior under reverse voltage is similar to a diode's VA characteristic - with a sharp knee at about 10% of rated voltage.

These parameters vary with temperature, which has a measurable influence on the entire circuit behavior, especially for low power applications. These are some of the reasons that real capacitors demonstrate significantly different performance versus ideal capacitors.

EQUIVALENT CIRCUIT DIAGRAM FOR A REAL CAPACITOR

An equivalent circuit diagram has been developed from ideal passive and semiconductor components (C, R, L, and D) to simulate the actual behavior of Tantalum and Niobium Oxide capacitors. The equivalent circuit diagram is shown in figure 1.

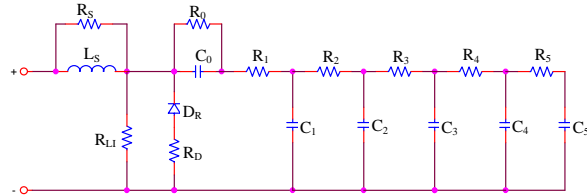

Figure 1: The structure of equivalent circuit diagram (independent on temperature)

The equivalent circuit consists of a ladder of ideal resistors R_1, R_2, R_3, R_4, R_5 and capacitors C_1, C_2, C_3, C_4, C_5 to describe decreasing capacitance (Figure 2) and drop in ESR (Figure 3) with

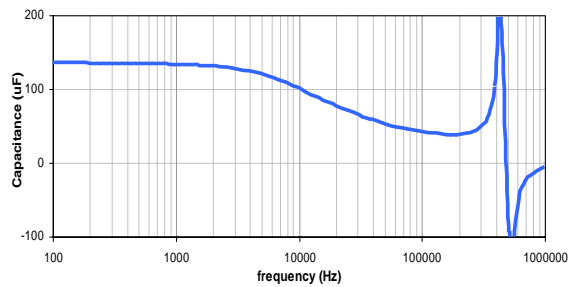

Figure 2: Capacitance behavior through the frequency range

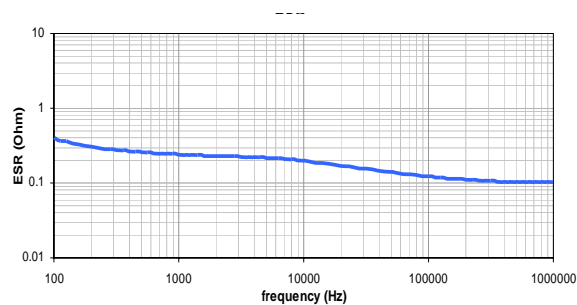

Figure 3: Reaction of ESR through the frequency

increasing frequency, which is characteristic of capacitors in general. The increased ESR level at low frequencies is described by the resistor R_0 and capacitor C_0 in parallel combination. The capacitance C_0 is many times higher than nominal capacitance of the capacitor, because this C_0 capacitance represents static electric charge on the capacitor. Self-inductance of the capacitor is modeled by the parallel combination of inductance L_S and resistance R_S to create a self-resonance behavior with the rest of circuit capacitance. R_S should attenuate the peak pulse of the self-resonance cycle.

Resistor R_{LI} describes leakage current (LI) through the component, because the value of resistor R_{LI} represents a linear change in the modeled capacitor's leakage current over application voltage range (figure 4).

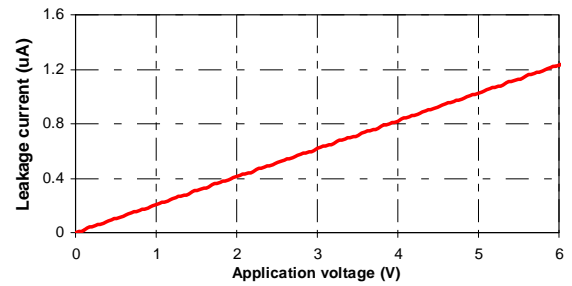

Figure 4: Leakage current representation in V-A characteristic

Equivalent resistance of leakage current could be easily recalculated through Ohm's law $R_{LI} = V_A / I_L$ from known application voltage V_A and resistance I_L .

Since Tantalum and Niobium Oxide capacitors are polar components with MIS (Metal Insulator Semiconductor) structure [1], the electrical behavior in reverse voltage is different from that under regular polarization [2]. In the reverse mode, tantalum and niobium oxide dielectrics are modeled by a diode D_R and resistor R_D integrated in the equivalent circuit diagram. The diode D_R has a bend at approximately 10% of the capacitor's rated voltage to describe the real change of capacitor's V-A curve. Serial resistance R_D describes the slope of V-A characteristic after the bend. The diode D_R and serial resistance R_D do not have any influence on leakage current of the capacitor since the diode D_R has negligible current in the diode's reverse mode. Detailed view of the reverse voltage behavior is visible in figure 5.

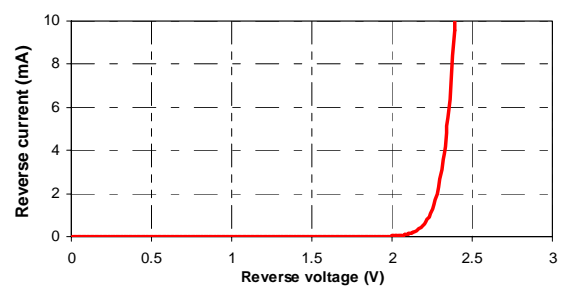

Figure 5: Reverse mode V-A characteristic

EXPLANATION OF TEMPERATURE DEPENDENT CAPACITOR MODEL

The equivalent circuit diagram includes temperature dependences, even though this is less significant for Tantalum and Niobium Oxide capacitors than for other technologies (tantalum polymer, aluminum polymer, high CV ceramic components etc.).

There are no voltage dependences included in the model, since Tantalum and Niobium Oxide capacitor characteristics are independent of DC bias voltage.

Real capacitors are temperature dependent and thus the components from the equivalent circuit are functions of temperature as is shown in figure 6.

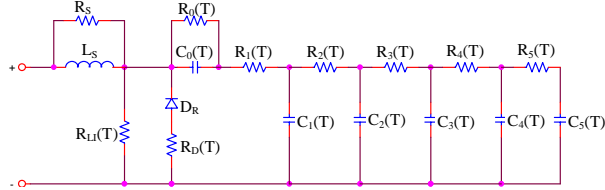

Figure 6: The structure of equivalent circuit diagram with temperature dependent components

The temperature dependence is accounted for by making resistor and capacitor values in the model functions of temperature: ($R_1(T)$, $R_2(T)$, $R_3(T)$, $R_4(T)$, $R_5(T)$) and ($C_0(T)$, $C_1(T)$, $C_2(T)$, $C_3(T)$, $C_4(T)$, $C_5(T)$). This mathematical explanation of temperature behavior can describe capacitance, ESR and Impedance reaction of the capacitor across the frequency spectrum. Figure 7 shows the capacitance and ESR response through temperature and frequency range.

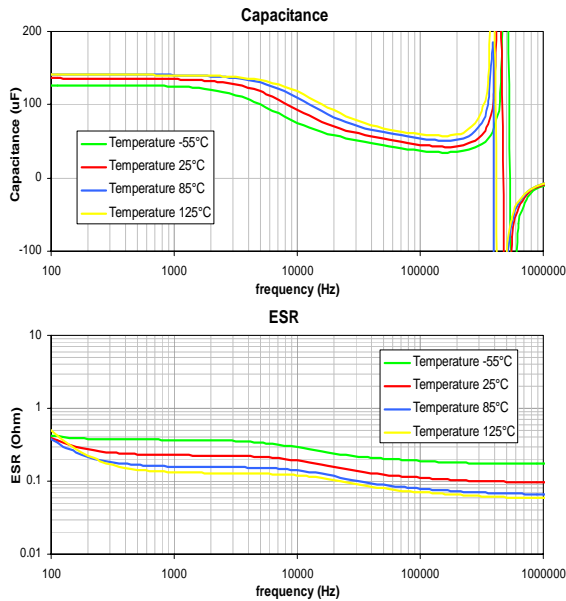

Figure 7: Capacitance and ESR behavior through the frequency range with temperature dependence

The leakage current of the capacitor is even logarithmically temperature dependent and this influence is included in the $R_{Ll}(T)$ temperature function, which means that the temperature is a key influence on leakage current magnitude. The leakage current can be transformed to the $R_{Ll}(T)=V_A/LI(T)$ by Ohm's law and its exponential explanation can look like the equation (1) below with detailed graphical view to plot in figure 8.

$$R_{Ll}(T) = R_{Ll25^{\circ}c} \cdot 1.39 \cdot e^{-0.013 \cdot T} \quad (1)$$

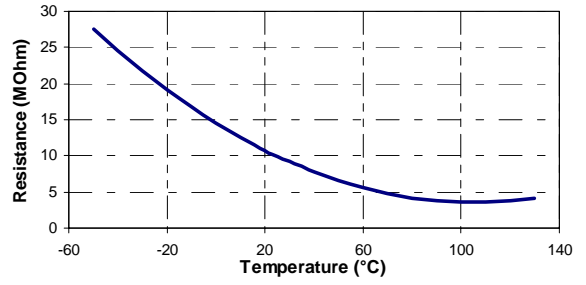

Figure 8: Temperature dependent value of equivalent R_{Ll} over temperature

TANTALUM AND NIOBIUM OXIDE CAPACITOR MODEL LIBRARY USED IN SIMULATION SOFTWARE

Today, simulation software is a nearly indispensable tool in efficient and flexible development and design of electronic equipment. The equivalent circuit models developed for Tantalum and Niobium Oxide capacitors have been assembled into a library for use in this simulation software. As described above, these models have been tuned to match the measurements of the actual components so that the model will yield the same performance in the simulation circuit as the actual component would in the real circuit. Figure 9 shows

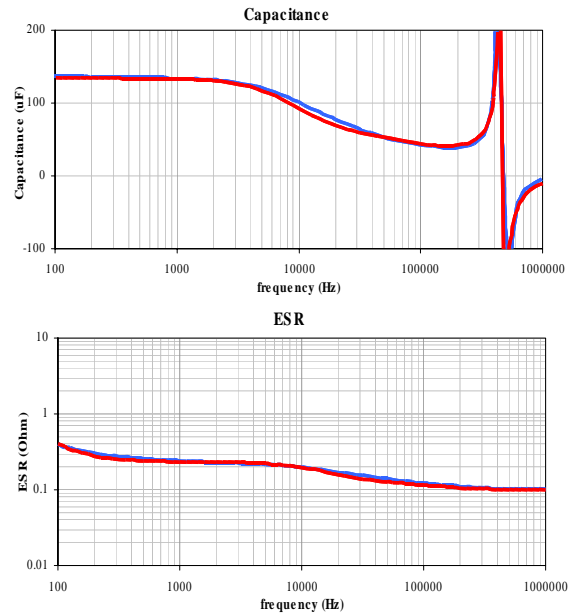

Figure 9: Matching real measurement and simulation response of equivalent circuit

how closely the behavior of the capacitor model matches the actual component.

Each library consists of two files: a netlist file, which includes a network of ideal components that represents the equivalent circuit diagram (Figure 6), including temperature dependences, and a component symbol file that contains symbols that represent the components on the circuit diagram.

The libraries contain models for all AVX Tantalum and Niobium Oxide capacitors, and can be imported into PSpice and other popular simulation software. [3].

The next chapter will describe the use of the library in creating simulation circuits.

These libraries are intended for use in both frequency and transient simulations over the full operating temperature range of each component. A complete designed circuit diagram could be built from many types of components (transistors, resistors, capacitors, diodes, inductors, integrated circuits, etc.). One such circuit diagram is shown in figure 10.

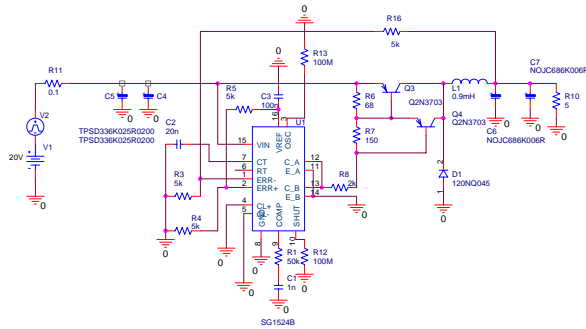

Figure 10: Example of circuit diagram suitable for simulation

For many practical purposes, the simulation result can be considered identical to what would be measured on the physical circuit. And simulation of the circuit is more efficient and more flexible than assembling the circuit from real components on a PCB, which can result in reduced overall time-to-market.

EXAMPLE OF CIRCUIT DIAGRAM CREATION WITH SIMULATED AND MEASURED RESULTS

This section gives examples creating circuit diagrams, their subsequent simulation, and results.

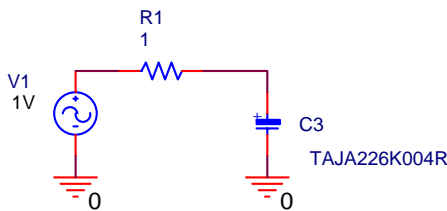

Figure 11: Basic circuit diagram of real capacitor simulation

Components are basically dragged and dropped onto the worksheet to create the circuit diagram (Figure 11). In this example the capacitor is connected with a sweeping source to demonstrate frequency response of electrical parameters and evaluate real capacitance, ESR and impedance characteristics. The results are shown against measurement of the actual device in figure 12.

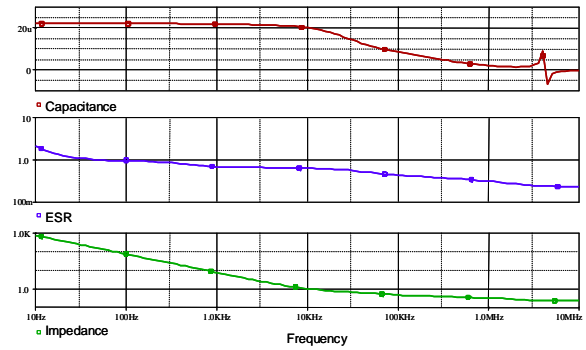

Figure 12: Capacitance, ESR and Impedance behavior of simulated real capacitor

Figure 13 shows a circuit diagram used to compare the level of smoothing given by tantalum and

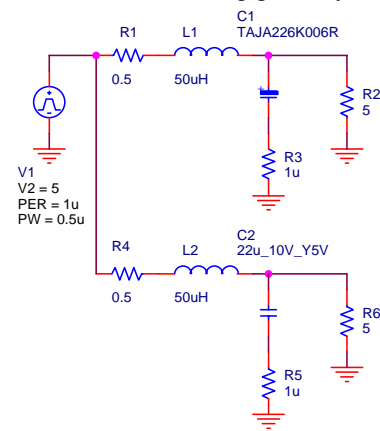

Figure 13: Circuit diagram of output passive filters comparison

ceramic capacitors in output passive filters. The output voltage ripple is shown in figure 14.

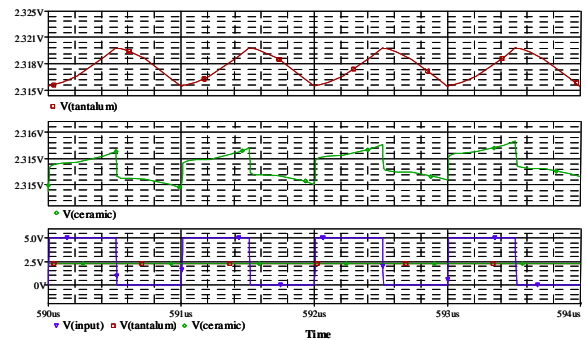

Figure 14: Simulation result of ripple voltage

In this case, the tantalum capacitor has a smoother voltage ripple characteristic $V(\text{tantalum})$ than the ceramic $V(\text{ceramic})$, where voltage spikes are present, although overall output filtering is similar. For comparison, the same circuit was assembled from actual components, and the measurements are shown in figure 15.

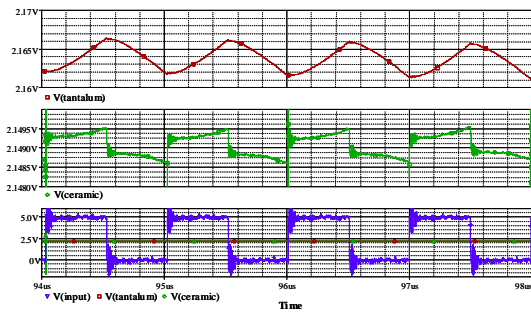

Figure 15: The result of measured ripple voltage level

A comparison of the simulation and measurements shows no significant differences. This proves the accuracy of the simulation. To a large extent, measurement can be replaced by simulation to yield a shorter development cycle.

The last example demonstrates the flexibility of simulating a real DC/DC converter (Figure 16). An



Figure 16: Physical DC/DC converter

actual DC/DC converter was measured and overloaded to create higher output voltage ripple to demonstrate that even an overloaded DC/DC converter can be successfully simulated.

The input and output voltage levels are shown in graphs of figure 17. The DC/DC converter was

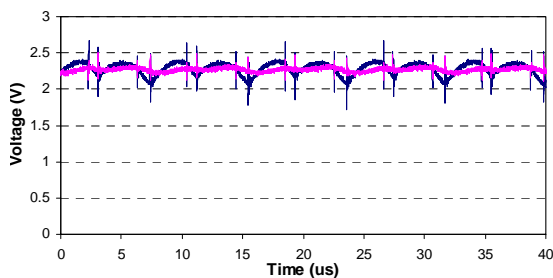

Figure 17: Measured result of voltage transient real DC/DC converter before and after output passive filter

both modeled in the simulation software and created from real circuit components (Figure 18). Figure 19 shows the result of the simulation. Here also the simulation result is identical to the measurement of the actual device, further proving the correct functionality of the equivalent circuit diagrams.

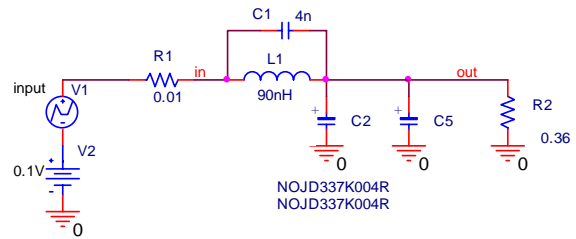

Figure 18: Circuit diagram for simulation of DC/DC converter output filter

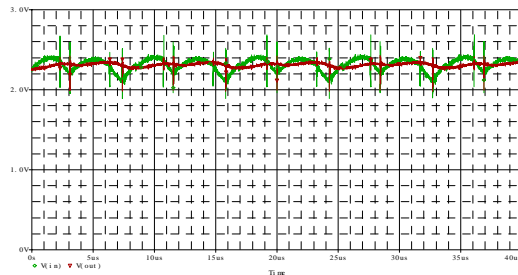

Figure 19: Simulation result voltage transient of DC/DC converter before and after output passive filter

SUMMARY

An equivalent circuit diagram for capacitors has been developed because of the need to include the non-ideal aspects of a real capacitor's behavior.

These models for all Tantalum and Niobium Oxide capacitors have been assembled into a library that can be incorporated into simulation software.

The library of electronic components for simulation software is a useful tool for fast, flexible electronic circuit design and development.

Component files from the library can be freely and widely used for frequency, transient, AC and DC analysis with real temperature behavior.

Examples were used to demonstrate the use of models of a variety of components together with models of Tantalum and Niobium Oxide capacitors to efficiently create an accurate circuit simulation.

REFERENCES

- [1] J.Sikula et al., Tantalum Capacitor as a MIS Structure; CARTS USA 2000, 102-106
- [2] A.Teverovsky, Reverse Bias Behaviour of Surface Mount Solid Tantalum Capacitors; CARTS USA 2002, 105-123
- [3] Penzar's TopSPICE (www.penzar.com) includes real Tantalum and Niobium Oxide capacitors libraries into simulation software



NORTH AMERICA
Tel: +1 864-967-2150

ASIA
Tel: +65 6286-7555

CENTRAL AMERICA
Tel: +55 11-46881960

EUROPE
Tel: +44 1276-697000

JAPAN
Tel: +81 740-321250

NOTICE: Specifications are subject to change without notice. Contact your nearest AVX Sales Office for the latest specifications. All statements, information and data given herein are believed to be accurate and reliable, but are presented without guarantee, warranty, or responsibility of any kind, expressed or implied. Statements or suggestions concerning possible use of our products are made without representation or warranty that any such use is free of patent infringement and are not recommendations to infringe any patent. The user should not assume that all safety measures are indicated or that other measures may not be required. Specifications are typical and may not apply to all applications.

